

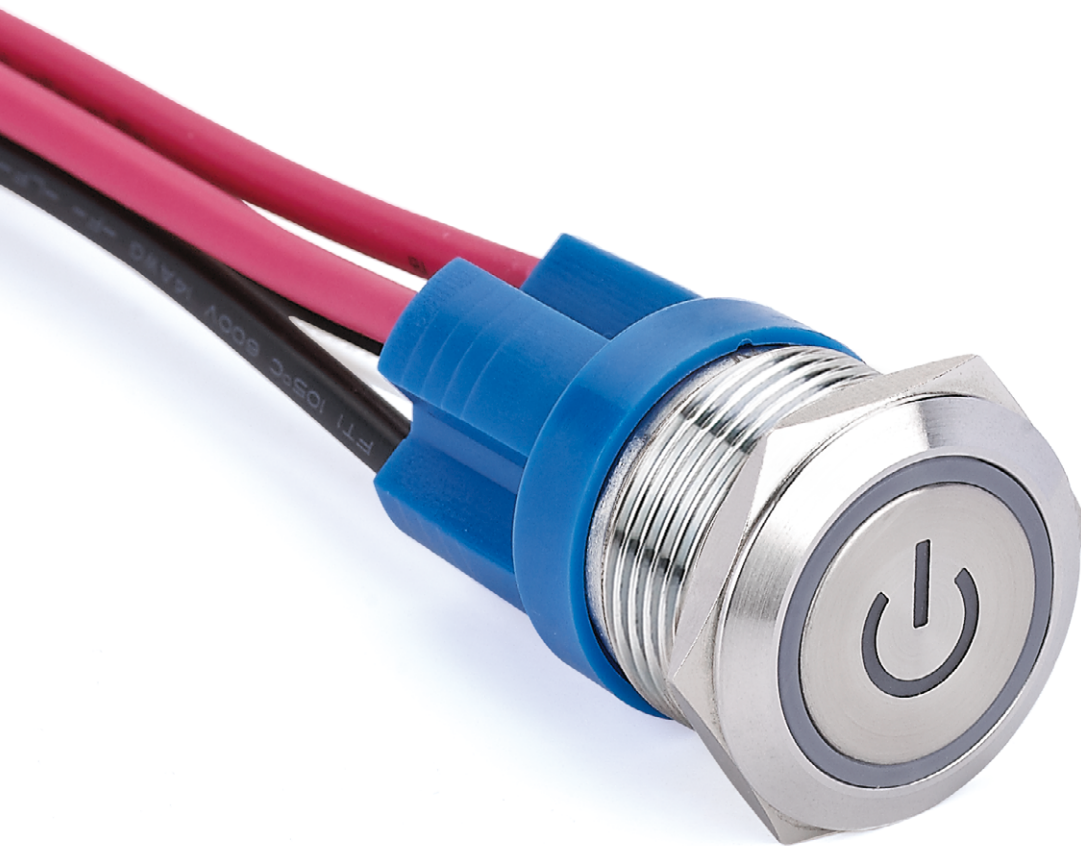

PRODUCT ***GUIDE*** 产品手册

ZHEJIANG HANSHANG ELECTRIC CO., LTD.



www.hungsing.cn
www.hs-switch.com

A multi-story brown building with a glass-enclosed vertical shaft on the left side. The building features numerous windows across its facade. At the top, a red logo consisting of the letters 'HS' is followed by the Chinese characters '瀚尚电气'. The sky is blue with scattered white clouds. In the foreground, there is a black metal fence, some green trees, and a paved parking lot with white markings. To the right, a portion of a white industrial-style building is visible.

HS 瀚尚电气

About HungSing

关于瀚尚

浙江瀚尚电气有限公司，本公司是专业从事按钮开关及配套产品的生产及技术开发的生产品型企业。产品广泛用于运动设备、生物制药、精密机械检测、船舶控制系统、自动机床、纺织机械、印刷及包装机械、食品加工机械、塑料机械等行业。

公司多年来专注生产金属按钮开关、塑料按钮开关、信号按钮灯等产品销售为一体的厂家，为世界知名品牌代工生产各种型号的按钮开关，产品具有世界先进技术，却坚持在国内以质优价低的产品销售，公司生产的按钮、信号灯系列得到了广大客户的厚爱和欢迎。

公司具有完善的经营体制。致力于以质量、品牌、服务、价格为企业与发展之本的宗旨，赢得世界各地的客户信赖与一致好评，始终期待着能成为您的合作伙伴，共创美好未来。

Zhejiang Hanshang Electric Co., Ltd. is a production-oriented enterprise specializing in the production and technology development of button switch and supporting products. Products are widely used in sports equipment, biopharmaceutical, precision machinery testing, ship control system, automatic machine tools, textile machinery, printing and packaging machinery, food processing machinery, plastic machinery and other industries.

Over the years, the company has focused on the production of metal button switches, plastic button switches, signal button lights and other products as one of the manufacturers, for the world famous brand OEM production of various models of button switches, products with the world's advanced technology, but adhere to the domestic product sales with high quality and low price, the company's production of buttons, signal lamp series has been loved and welcomed by the majority of customers.

The company has a sound management system. Committed to quality, brand, service, price for the purpose of enterprise and development, to win the trust and praise of customers around the world, always looking forward to become your partner, create a better future.



精益智造 品质更出众

Fine intelligence makes the quality more outstanding



贴心定制 细致服务

Intimate custom and meticulous service



QUALIFICATIONS

企业资质

权威认证，品质卓越；
凝聚瀚尚人的辛勤和智慧；
更衬托出瀚尚人对品质至上的追求，一次次的荣誉积淀成长的印象；
亦是一次次对未来的鞭策 ...

Authoritative certification, excellent quality;
Condensed Han Shang people's hard work and wisdom;
It also sets off the Hanshang people's pursuit of quality first, and
the impression of honor accumulation and growth again and
again;it is also a spur to the future...





Hungsing

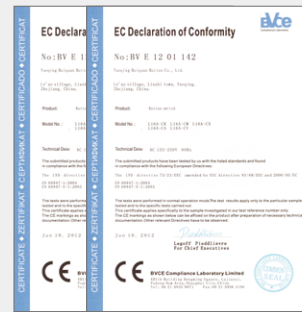
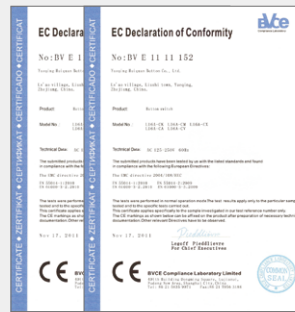

PRODUCT CONTENTS

产品目录

X 系列 X SERIES

X 系列抗破坏防水金属信号灯 X Series destruction-resistant waterproof metal indicator light	01
---	----

A 系列 A SERIES

A 系列按钮开关 A Series metal push button switch	07
---	----

A2 系列按钮开关 A2 series push button switch	15
---	----

56A 系列按钮开关 56A series push button switch	20
---	----

B 系列 B SERIES

B 系列按钮开关 B series push button switch	24
---	----

C 系列 C SERIES

12C 系列按钮开关 12C Series push button switch	29
---	----

16C/19C/22C 系列按钮开关 16C/19C/22C series push button switch	33
---	----

D 系列 D SERIES

D 系列按钮开关 D series push button switch	39
---	----

E 系列 E SERIES

8E 系列按钮开关 8E series push button switch	43
---	----

12E 系列按钮开关 12E series push button switch	46
---	----

16E 系列按钮开关 16E series push button switch	50
---	----

F 系列按钮开关 F series push button switch	54
---	----

QC 系列按钮开关 QC series push button switch	59
---	----

M 系列按钮开关 M series push button switch	62
---	----

U 系列塑料按钮开关 U series plastic button switch	67
--	----

A 系列塑料按钮开关 A Series plastic push button switch	71
---	----

CT 系列急停按钮 CT series emergency stop button	76
--	----

三色警示灯系列 Three-color warning light series	79
---	----

附件 Attachments	84
-------------------	----

LA38 系列 LA38 SERIES

LA38 按钮开关 LA38 Button switch	88
---------------------------------	----

LD16 系列 LD16 SERIES

LD16 信号指示灯 LD16 Signal indicator	97
-------------------------------------	----



概述 /summarize

本公司生产的金属高强度抗破坏按钮、指示灯产品及塑料按钮不仅美观大方，还具备了多品种、多规格、多用途等优点，满足了各行业领域客户的不同要求，被广泛应用于各种工业柜体、家用电器等机电仪器行业的键面控制系统中。

为了客户更好的选用我们的产品，以下表格中简略列出了产品的型号、面板安装尺寸、电子构造、电气规格以及种类等参数，产品的详细介绍请根据表中提供的页码在说明书中仔细阅读了解。

The metal high-strength anti-vandalism buttons, indicator products and plastic buttons produced by our company are not only beautiful and generous, but also have the advantages of multi-species, multi-specification, multi-purpose, etc., to meet the different requirements of customers in various industrial fields, and are widely used in various industrial cabinets, household appliances and other electromechanical instrumentation industry in the key surface control system.

In order for customers to better choose our products, the following table briefly lists the product model number, panel mounting dimensions, electronic structure, electrical specifications, and types of parameters, product details please read carefully in the manual according to the page number provided in the table to understand.

外壳材质视觉对比 /Visual comparison of housing materials

描述 descriptive	黄铜镀镍 (镜面效果) Nickel-plated brass (mirror effect)	不锈钢 (螺旋纹效果) Stainless steel (spiral effect) aluminum oxide	铝氧化 aluminum oxide
视觉效果图 visualization			

注：外壳可按要求定制加工上色（外壳材料可改用铝合金）。

Note: Shell can be customized according to the requirements of processing color (shell material resistant to change to aluminum alloy).

内置防水圈示意图
Built-in waterproof ring schematic

内置防水圈
Built-in waterproof ring

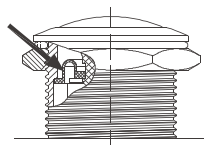

防水圈安装效果图
Waterproof ring installation effect

O型防水圈
O-type waterproof ring

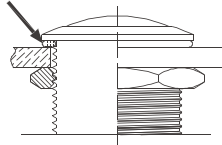

平型防水圈
Flat waterproof ring

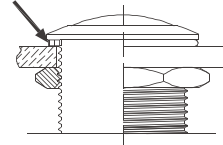

注：不同产品默认防水圈不同，客户也可根据需要要求更换水圈。

Note: Different products default waterproof ring is different, customers can also replace the water ring according to needs.

部分产品焊接注意事项 /Welding Precautions for Some Products

任何不正确的焊接操作都可能导致产品塑性变形、开关接触不良等。用户在使用引脚式按钮开关、信号灯时，因焊接不当导致产品损坏的现象时有发生，故请各位用户在接线操作时务必注意以下几点：

- 1、选择合适的电烙铁，加快焊接速度，建议使用 20W 电烙铁 3 秒内完成焊接。
- 2、助焊剂必须适量，焊接时尽量将开关引脚朝下。
- 3、尽量采用插线端子连接，避免焊接连接。

Any incorrect soldering operation may result in plastic deformation of the product, poor switch contact, etc. Users in the use of pin-type pushbutton switches, signal lamps, due to improper welding led to product damage occurs from time to time, so please be sure to pay attention to the following points in the wiring operation:

- 1、choose the right soldering iron to speed up the welding speed, it is recommended to use 20W soldering iron within 3 seconds to complete the welding.
- 2、The flux must be in the right amount, and the switch pins should be facing down as much as possible when soldering.
- 3、The connection should be made by plug-in terminals as far as possible, avoiding soldered connections.

订货须知 /Order instructions

- 1、订货时请对照“型号说明”与产品具体说明内容填写型号代号。
- 2、所有产品均可定制铝质外壳，表面上色处理（定制彩色外壳）。
- 3、产品如需定做，数量须在 1000 只以上。
- 4、所有产品的防护等级仅限于面板前部。

- 1、When ordering, please fill in the model code against the "Model Description" and the specific description of the product.
- 2、All products can be customized with aluminum housing and surface color treatment (customized color housing).
- 3、Products need to be customized, the quantity must be more than 1000 pieces.
- 4、The Protection level rating of all products is limited to the front of the panel.

IP 防护等级说明 / Description of IP protection level

第一位数码 (防止固体异物进入) The first digit (to prevent the entry of solid foreign bodies)		第二位数码 (防止进水造成有害影响) Brief description of the second digit (preventing harmful effects of water ingress)				
IP	要求 Requires	举例 Example	IP	简述 Sketch	举例 Example	防水 Waterproof
0	无防护 Unprotected		0	无防护 Unprotected	无 NO	无防护 Unprotected
1	直径 50mm 的球型物体不得完全进入, 不得触及危险部件。如手背。 Spherical objects with a diameter of 50 mm must not be fully accessible and must not touch dangerous parts. Like the back of the hand.		1	防止垂直下落滴水, 允许少量水进入 Prevents vertical drop dripping, allows small amounts of water to enter		垂直滴水 Vertical dripping
2	直径 12.5mm 的球型物体不得完全进入, 铰接试指应与危险部件有足够的间隙。如手指。 Spherical objects with a diameter of 12.5 mm shall not be fully accessible and the articulated test finger shall have sufficient clearance from the hazardous part. Like fingers.		2	防止当外壳在 15° 范围内倾斜时垂直下落滴水, 允许少量水进入 Prevents dripping when the housing is tilted vertically within 15°, allowing a small amount of water to enter		与垂直面成 15° 滴水 Drip water at 15° with the vertical plane
3	直径 2.5mm 的试具不得进入。如工具。 Test pieces with a diameter of 2.5 mm are not allowed to enter. Such as tools.		3	防止与垂直面成 60° 范围内淋水, 允许少量水进入 In the housing is tilted vertically within 60°, allowing a small amount of water to enter		少量淋水 Drizzle with a small amount of water
4	直径 1mm 的试具不得进入。如金属丝。 Test pieces with a diameter of 1 mm are not allowed to enter. Such as metal wires.		4	防止任何方向的溅水, 允许少量水进入 Prevents splashing water in any direction, allowing a small amount of water to enter		任何方向的溅水 Splashes of water in any direction
5	允许有限的灰尘进入 (没有有害的沉积)。完全防止灰尘进入。 Allows limited dust entry (no harmful deposits). Completely protects against dust ingress.		5	防止喷水, 允许少量水进入 Prevents water spray and allows a small amount of water to enter		任何方向的喷水 Water spray in any direction
6	完全防止灰尘进入。 Completely protects against dust ingress.		6	防止强烈喷水, 允许少量水进入 Prevents strong water sprays and allows a small amount of water to enter		任何方向的强烈喷水 Strong spray of water in any direction
			7	防止 0.15m~1m 深的浸水影响 Prevent the influence of water immersion at a depth of 15mm~1m		短时间浸水 Soak in water for a short time
			8	防止在有压力下长期浸水 Prevents long-term immersion in water under pressure		持续浸水 Sustained flooding



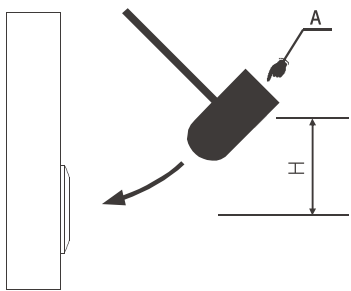

























































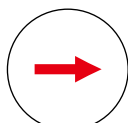
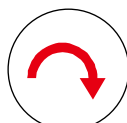
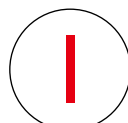

外壳 IK 防护等级说明 / Housing IK Protection level description

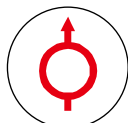
IK 防护等级 IK Protection level	IK 防护等级 IK Protection level	锤初始高度 H Hammer initial height H	撞击能量 Impact energy	撞击示意图 Schematic diagram of the impact	说明 Instruction
IK01	150g	10cm	0.15J		外壳的相同部位在受到 3 次相应等级能量的机械撞击后, 不使开关受到有害影响。 The same part of the housing is not subject to harmful effects on the switch after being subjected to 3 mechanical impacts of the corresponding level of energy.
IK02	200g	10cm	0.2J		
IK03	250g	15cm	0.35J		
IK04	250g	20cm	0.5J		
IK05	350g	20cm	0.7J		
IK06	250g	40cm	1J		
IK07	500g	40cm	2J		
IK08	1.25Kg	40cm	5J		
IK09	2.5Kg	40cm	10J		
IK10	5Kg	40cm	20J		

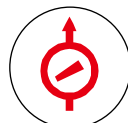
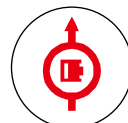
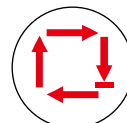
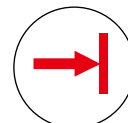
注: 符合标准: GB/T20138-2006, IEC62262:2002
采用试验标准: GB/T2423.55-2006, IEC60068-2-75:1997

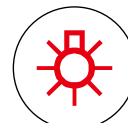
Note: In line with the standard: GB/T20138-2006, IEC62262: 2002
Test standard: GB/T2423.55-2006, IEC60068-2-75:1997

标识列举 / Pattern enumeration

文字标识 Text	 1	 2	 3	 4	 5	 6	 7	 8	 9	 10
	 11	 12	 13	 14	 15	 16	 17	 18	 19	 20
	 21	 22	 23	 24	 25	 26	 27	 28	 29	 30
数字及符号 Numbers and symbols	 31	 32	 33	 34	 35	 36	 37	 38	 39	 40
	 41	 42	 43	 44	 45	 46	 47	 48	 49	 50
ISO 部分符号 ISO symbols	 51直线移动	 52转动	 53启动	 54停止	 55启动停止	 56点动				
	 57泵	 58冷动泵	 59润滑泵	 60液压泵	 61自动或半自动循环	 62限位直线移动				
特殊符号 Special symbols	 63	 64	 65	 66	 67	 68				

注：以上图标符号均需定制。

Note: The above icon symbols need to be customized.



浙江瀚尚电气有限公司
ZHEJIANG HANSHANG ELECTRIC
CO., LTD.



X SERIES

X 系列抗破坏防水金属信号灯

X Series destruction-resistant waterproof metal signal indicator

防水 IP65/IP67，可直接在户外场景使用。

金属外壳，防止使用过程中各种撞击产生的开关失效现象。

发光面可订制各种图案，使信号指示明确无误。

Waterproof IP65/IP67, can be used directly in outdoor scenes.

Metal shell to prevent switch failure caused by various impacts during use.

The luminous surface can be customized with various patterns, so that the signal indication is clear and unmistakable.



抗震耐摔
shock-resistant



防水防尘
Waterproof and dustproof



安全实用
Safe and practical



品质保证
Quality assurance

型号说明 / Model description

企业代号 Business code	外壳材质 Housing material	安装孔尺寸 Mounting hole size	头部形状 Head shape	接线类型 Wiring type	带灯颜色 LED color	带灯部分电压 LED voltage
H	JU 铜镀镍 Nickel-plated brass	6 Φ6mm	X 平圆形 Flat round	S 焊接脚 Welding pins	R 红 Red	AC/DC 3V
	JA 铝氧化 Aluminum oxide	8 Φ8mm	XA 球形 Spherical	M 接线柱 Terminal	G 绿 Green	AC/DC 6V
	JG 不锈钢 Stainless steel	10 Φ10mm	XS 短款平圆形 Short flat round	L 自带线束 Equipped with wiring harness	Y 黄 Yellow	AC/DC 12V
		12 Φ12mm			B 蓝 Blue	AC/DC 24V
		14 Φ14mm			WT 白 White	AC/DC 36V
		16 Φ16mm				AC/DC 48V
		19 Φ19mm				AC/DC 110V
		22 Φ22mm				AC/DC 220V
		25 Φ25mm				
		30 Φ30mm				

注：请仔细阅读产品具体说明后，根据不同符号在该表中选取相应代号。
定制特殊图案请与销售人员沟通确认。

Note: Please read the specific description of the product carefully, and select the corresponding code in the table according to different symbols.

概述 / Summary

安装孔尺寸 Mounting hole size	Φ6-Φ30mm
电压等级 Voltage level	220V 及以下 220V and below
额定电流 Ie Rated current Ie	3~48V 约 15mA; 110~220V 约 2mA 3~48V about 15mA; 110~220V about 2mA
灯珠类型 LED type	双向 LED 灯珠 (交直流通用) Two way LED beads (AC and DC universal)
灯珠颜色 LED color	R Y G B W (可定制三色或双色) Three or two colors can be customized
外壳材料 Housing material	不锈钢 / 黄铜 (镀铬) / 铝 (氧化) Stainless steel / brass (chrome plated) / aluminum (oxidized)
防护等级 Protection level	IP65/IP67 IK10

注：如需单向直流 LED 灯珠可定做；其他电压规格可按要求定做。

Note: If unidirectional DC LED lamp beads are required, they can be customized; Other voltage specifications can be customized as required.

性能特征 / Performance characteristics

产品规格 Product specifications	HJ □ □ X- ◆ □	
尾部配置 Bottom configuration	接线插片 (2.8×0.5mm) Wiring pins (2.8×0.5mm)	
绝缘强度 Dielectric strength	1100VAC	
环境温度 Ambient temperature	-20°C ~ +55°C	
面板厚度 Panel thickness	1 ~ 8mm	
螺母扭矩 Nut torque	5 ~ 14Nm	
防护等级 Protection level	IP65/IP67 IK10	
材料 Material	灯罩 LED shade	聚碳酸酯 Polycarbonate
	外壳 Housing	黄铜镀铬 Chrome plated brass
	基座 Pedestal	PBT
	RoHS	可定制 Customizable
灯珠参数 LED specification	灯珠类型 LED type	双向 LED 灯珠 (交直流通用) Two way LED beads (AC and DC universal)
	额定电压 Ue Rated voltage Ue	3V / 6V / 12V / 24V / 36V / 48V / 110V / 220V
	灯珠颜色 LED color	R Y G B W (可定制三色或双色) Three or two colors can be customized
	灯珠寿命 LED life	40000 小时 40,000 hours



金属信号指示灯 /Metal signal indicator



φ8

HJ □ 8X/ □ /S

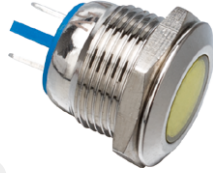

φ12

HJ □ 12XS/ □ /S



φ12

HJ □ 12XS/ □ /M



φ16

HJ □ 16XS/ □ /S



φ16

HJ □ 16XS/ □ /M



φ12

HJ □ 12X/ □ /S



φ16

HJ □ 16X/ □ /S



φ16

HJ □ 16X/ □ /M



φ19

HJ □ 19X/ □ /S

外形尺寸 /Outline size

*HJ □ 8X

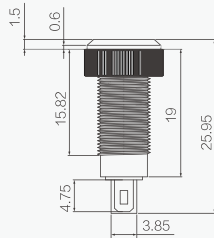

注: * 可选按钮开孔直径 φ8mm

Note: * Optional button opening diameter φ8mm

**HJ □ □ XS/S

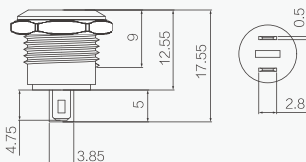

** 可选按钮开孔直径 φ16、19mm

**Optional button opening diameter φ16、19mm

**HJ □ □ XS/M

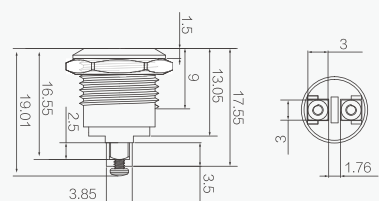

金属信号指示灯 /Metal signal indicator



更多产品信息
请详询本公司!
More Product Information
Please contact us for details!

外形尺寸 /Outline size

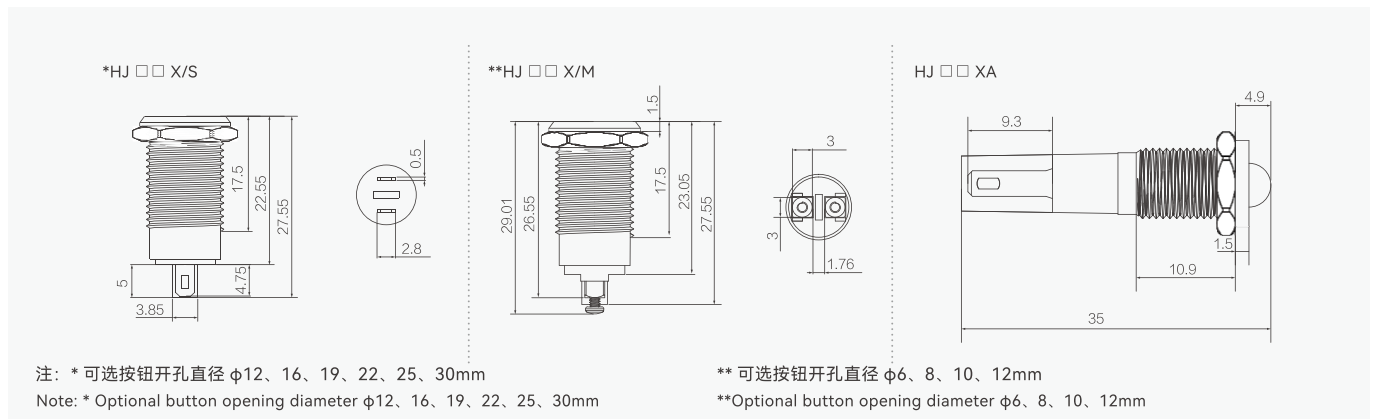



金属信号指示灯 / Metal signal indicator



外形尺寸 / Outline size

*HJ □ □ XB

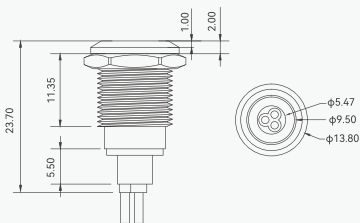

注: * 可选按钮开孔直径 φ6、8、10、12mm

Note: * Optional button opening diameter φ6、8、10、12mm

**HJ □ □ XC/S

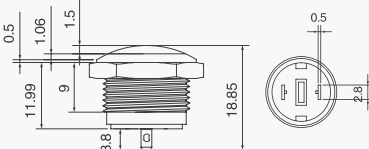

** 可选按钮开孔直径 φ12、16、19、22、25、30mm

**Optional button opening diameter φ12、16、19、22、25、30mm

**HJ □ □ XC/M

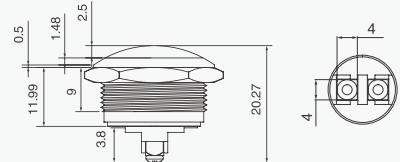

金属信号指示灯 /Metal signal indicator



外形尺寸 /Outline size

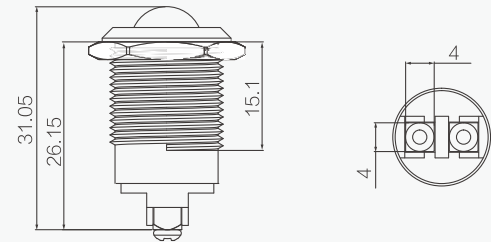
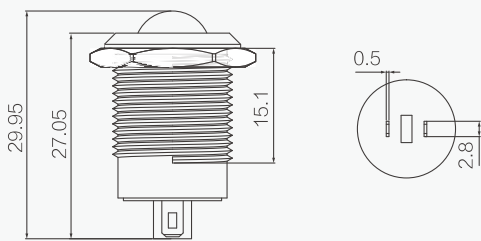

注：可选按钮开孔直径 $\phi 16$ 、 19 、 22 mm
Note: Optional button opening diameter $\phi 16$ 、 19 、 22 mm





浙江瀚尚电气有限公司
ZHEJIANG HANSHANG ELECTRIC
CO., LTD.



A SERIES

A 系列金属按钮开关

A Series metal push button switch

防水 IP65/IP67，可直接在户外场景使用。

金属外壳，防止使用过程中各种撞击产生的开关失效现象。

发光面可订制各种图案，使信号指示明确无误。

Waterproof IP65/IP67, can be used directly in outdoor scenes.

Metal shell to prevent switch failure caused by various impacts during use.

The luminous surface can be customized with various patterns, so that the signal indication is clear and unmistakable.



抗震耐摔
shock-resistant



防水防尘
Waterproof and dustproof



安全实用
Safe and practical



品质保证
Quality assurance

型号说明 / Model description

企业代号 Business code	外壳材质 Housing material	安装孔尺寸 Mounting hole size		系列号 Serial number	触点结构 Contact structure		操作类型 Operation mode	带灯类型 With LED		头部形状 Head shape		接线类型 Wiring type	带灯颜色 LED color		带灯部分电压 LED voltage
		16	Φ16mm		11	1NO 1NC		D	面部大范围 Entire surface	P	平头 flat head		Q	焊接脚 Welding pins	
H	JU 铜镀镍 Nickel-plated brass	19	Φ19mm	A1	22	2NO 2NC	D	信号指示灯 Signal indicator	D1	点灯 Dot	T	高平头 High flat head	G	绿 Green	AC/DC 3V
		22	Φ22mm	A3			Z	自锁 Latching	D2	环形灯 Ring			Y	黄 Yellow	AC/DC 6V
		25	Φ25mm	A6			无	自复 Momentary	D3	电源标识灯 Power icon			B	蓝 Blue	AC/DC 12V
	JA 铝氧化 Aluminum oxide						CY	旋钮 Knob		电源标识灯 Power icon			WT	白 White	AC/DC 24V
	JG 不锈钢 Stainless steel						CK	钥匙钮 key push button	D4	加环形灯 Power icon with ring					AC/DC 36V
	L 塑料 Plastics						CV	急停钮 Emergency stop button							AC/DC 48V
						CU	蜂鸣器 Buzzer							AC/DC 110V	
														AC/DC 220V	

注：请仔细阅读产品具体说明后，根据不同符号在该表中选取相应代号。
定制特殊图案请与销售人员沟通确认。铝氧化（彩色），下单请注明颜色，
HJ □ 16A 默认为黄铜镀铬外壳，其余默认为不锈钢外壳。

Note: Please read the specific description of the product carefully, and select the corresponding code in the table according to different symbols.
Customize special patterns, please communicate with sales staff to confirm. aluminum oxide (color), Please specify color when ordering,
HJ □ 16A default housing Chrome plated brass, the rest default housing stainless steel.

概述 / Summary

安装孔尺寸 Mounting hole size	Φ16、19、22、25mm
开关额定值 Switch rating	3A/250V
开关组合 Switch combinations	1NO 1NC / 2NO 2NC
操作类型 Operation mode	自复式 / 自锁式 Momentary/Latching
头部形状 Head shape	平圆形 / 高圆形 Flat head / High flat head
外壳材料 Housing material	不锈钢 / 铝（氧化） 黄铜镀镍 Stainless steel/aluminum (oxidized) Nickel-plated brass
带灯方式 With LED	环形灯 / 电源标灯 Ring / power indicator light
防护等级 Protection level	IP65/IP67 IK09
灯珠类型 LED type	双向 LED 灯珠（交直流通用） Two way LED beads (AC and DC universal)
额定电流 Ie Rated current Ie	5~48V 约 15mA; 110~250V 约 2mA 5~48V about 15mA; 110~250V about 2mA
降压方式 Voltage reduction method	内置电阻 Built-in resistance
灯珠等效 Beads equivalent	采用交直流通用的 LED 灯珠，接线端子无正负极区分灯珠内置保护电阻，不需外接。 Using AC and DC universal LED lamp beads, the terminal has no positive and negative poles to distinguish the built-in protection resistance of the lamp beads, and does not need to be connected.
电路 Circuit	

开关结构说明 / Switch structure description

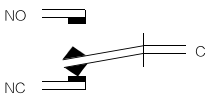
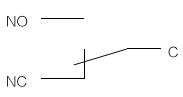
型式 / Type	示意图 / Schematic diagram	符号 / Symbol
C		

引脚说明 / Pin description

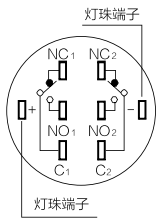

最多可配置两组开关。

C、NO、NC 和 C、NO、NC 分别为一组开关；C 脚为公用脚，NO 脚为常开脚，NC 脚为常闭脚；+、- 脚为灯珠引脚，常规灯珠配置无正负极区分。灯珠与开关相对独立，可通过开关或外围电路控制灯珠状态。

Up to two sets of switches can be configured.

C, NO, NC and C, NO, NC are a set of switches; C foot is common foot, NO foot is normally open foot, NC foot is normally closed foot; +, - pins are lamp bead pins, and conventional lamp bead configuration has no positive and negative polar distinction. The lamp beads are relatively independent of the switch, and the lamp bead status can be controlled by the switch or peripheral circuit. Lamp bead terminals

性能特征 / Performance characteristics

产品规格 Product specifications	HJ □□ A- □■ / □ / Q	机械寿命 Mechanical life	20 万次以上 More than 200,000 times		
绝缘强度 Dielectric strength	1500VAC	电气寿命 Electrical life	10 万次以上 More than 100,000 times		
绝缘电阻 Insulation resistance	≥ 1000MΩ	面板厚度 Panel thickness	1~10mm		
接触电阻 Contact resistance	≤ 50mΩ	螺母扭矩 Nut torque	5~14Nm		
开关规格 Switch specifications	3A/250V	操作压力 Operating pressure	3N~5N		
尾部配置 Bottom configuration	接线插片 (2.8×9mm) Wiring pins (2.8×9mm)	操作行程 Operation travel	约 3.1mm Approx. 3.1mm		
头部形状 Head shape	高平头 / 平头 High flat head/flat head	防护等级 Protection level	IP65/IP67 IK09		
环境温度 Ambient temperature	- 20°C ~+55°C				
材料 Material	触点 Contact	纯银镀金 Sterling silver gilded	带灯部分参数 LED parameter	灯珠类型 LED type	双向 LED 灯珠 (交直流通用) Two way LED beads (AC and DC universal)
	按键 Button	不锈钢 / 黄铜镀铬 / 铝 (氧化) Stainless steel / Chrome plated brass / aluminum (oxidized)		额定电压 Ue Rated voltage Ue	3V / 6V / 12V / 24V / 36V / 48V / 110V / 220V
	外壳 Housing	不锈钢 / 黄铜镀铬 / 铝 (氧化) Stainless steel / Chrome plated brass / aluminum (oxidized)		灯珠颜色 LED color	R Y G B W
	基座 Pedestal	PBT		灯珠寿命 LED life	40000 小时 40,000 hours
RoHS	可定制 Customizable				

金属按钮开关 /Metal push button switch



外形尺寸 /Outline size

